

POWERS® Controls

Air Line Filter Assembly

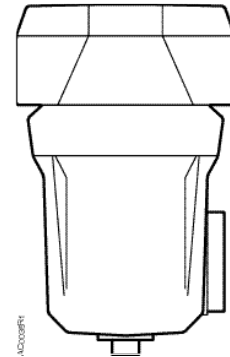

Description

The AF 908 Air Line Filter Assembly removes particulate matter, oil, and water from a compressed air source. The filter element coalesces oil and water droplets, converting them into bulk liquid that is easily drained from the housing. The particulate rating also ensures retention of solid particles. The unit is readily maintained without disassembly of the connecting piping.

Features

- Patented design maintains high oil removal efficiency for the life of the filter element
- Removes 99.999+ % of oil aerosols (remaining oil is in a vapor state)
- Removes solid particles 0.01 microns and larger

Application

Use the AF 908 filter assembly on pneumatic control systems to protect control devices against liquid or particulate contamination.

Product Numbers

908-051 Air Line Filter Assembly
908-052 Replacement Filter Element

Warning/Caution Notations

WARNING



Personal injury or loss of life may occur if you do not perform a procedure as specified.

CAUTION



Equipment damage may occur if you do not follow a procedure as specified.

Specifications

Operating	Maximum pressure	300 psig (2068 kPa)
	Nominal capacity @ 100 psig	20 scfm (33.9 m ³ /h)
	Nominal pressure drop	3 psi (20.68 kPa)

Specifications

(Continued)

Operating Maximum recommended pressure drop 10 psi (68.9 kPa)

	<p>CAUTION:</p> <p>Under no circumstances should the pressure differential across the filter exceed 50 psi (345 kPa); an excess pressure can cause failure of the filter element.</p>
---	--

Removal rating (microns)	
Particles	0.01
Oil and water	0.01
Operating Temperature	32°F to 150°F (0°C to 66°C)

Physical	Upper housing	zinc die-cast
	Bowl	aluminum die-cast
	Mounting	vertical
	Inlet and outlet	3/8-inch NPT
	Drain	3/8-inch manual drain
	Dimensions	See Figure 1

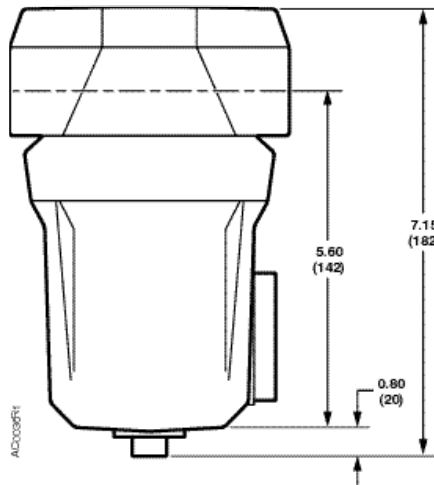

Figure 1. Air Line Filter Assembly Dimensions in Inches (Millimeters).

Operation

Air enters the AF 908 filter assembly and flows through a filter element. The filter element consists of three layers: an inner foam sleeve, a middle filter media that is a bed of submicronic glass fibers, and an outer foam sleeve.

The inner foam sleeve acts as a pre-filter and flow disperser. During operation, the inner foam sleeve expands against the middle filter media and eliminates any voids or liquid pockets. This maintains high efficiencies over a wide range of flow rates. The large non-wicking outer foam sleeve coalesces oil and water droplets and drains them into the filter sump. The extra large, non-wetting outer foam sleeve prevents any re-entry of the liquid droplets.

Sizing

The AF 908 coalescing filter assembly is rated for a nominal 20 scfm @ 100 psig (33.9 m³/h @ 689 kPa) flow to the system. It is recommended for use on all systems up to this nominal capacity. Larger installations may require a special filter or a parallel installation of several standard filters.

NOTE: Nominal air capacities vary with supply pressures. For example, a reduction of supply pressure from 100 to 70 psig (689 to 482 kPa) reduces the nominal air capacity from 20 to 14.8 scfm (33.9 to 25.1 m³/h).

The following formula provides a typical method of filter sizing with allowance for percentage of compressor running time:

$$\frac{\text{Compressor CFM} \times \% \text{ Operation}}{\text{Filter Capacity in scfm}} = \text{Number of Filters Required}$$

NOTE: For larger installations with parallel or multiple filters, round up the resulting *Number of Filters Required* to the next highest whole number.

Installation

Downstream of Refrigerated Air Dryers

A refrigerated air dryer tends to condense and drain away both water and oil during normal operation. Install the AF 908 filter assembly on the side *leaving* the refrigerated air dryer before the pressure reducing valve. This installation position can also extend the life of the filter element.

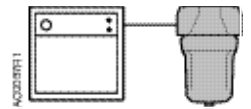

Upstream of Desiccant or Membrane Air Dryers

A desiccant air dryer using silica gel can become inoperative if the desiccant is coated with oil, which prevents absorption of water. Install the AF 908 filter assembly on the side *entering* the desiccant air dryer to extend the operating life of the dryer.

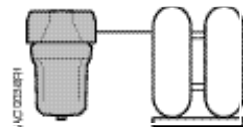

Downstream of Pressure-Swing Desiccant Dryers

Install the AF 908 filter assembly on the side *leaving* the desiccant air dryer to remove fine particulates.

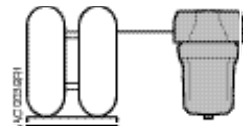

Service

	<p>WARNING: Failure to depressurize filter bowl before servicing or use of compressor lubricants other than those specified by Siemens Industry, Inc. can result in filter bowl fracture and serious injury.</p>
---	--

Maintenance

Drain is a manual port. Periodically drain any liquid accumulation in the filter bowl to prevent blocking of the filter element.

Repair

If the AF 908 air line filter assembly becomes inoperative, replace the device.

Service (Continued)

Filter Element Replacement

The filter element should provide a minimum life of approximately 1500 hours of continuous operation at rated capacity. For maximum filtration efficiency, replace the element when the pressure drop reaches 10 psi (69 kPa) or annually, whichever occurs first.

Use a 908-052 filter element to replace the filter element (Figure 2) in an AF 908 filter assembly as follows:

1. Isolate the filter by closing the inlet and outlet valves, if installed, or by shutting off the air supply.
2. Depressurize the filter by *slowly* opening the manual drain valve.
3. Remove the bowl by pushing the bowl up, turning 1/8 turn counterclockwise, and pulling the bowl straight down.
4. Clean the filter bowl.
5. Replace the element as follows:
 - a. Pull off the old element and discard it.
 - b. Make certain the O-ring inside top of the replacement element is in place.
 - c. Push the element onto the filter head until it seats.

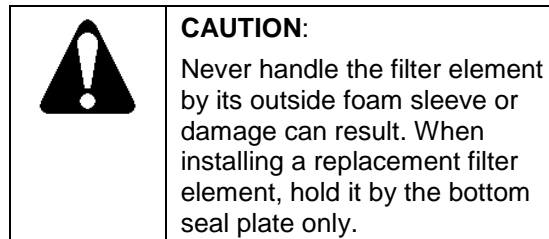

6. Ensure that the O-ring inside the collar of the bowl and the wave spring are in place. Reassemble the bowl to head.

NOTE: Ensure that the O-ring is generously lubricated. Also, the wave spring ends should point down so the wave spring does not interfere with re-assembly.
7. Re-apply system pressure to the filter by *slowly* opening the outlet and inlet valves, if installed, or by *slowly* turning on the air supply.

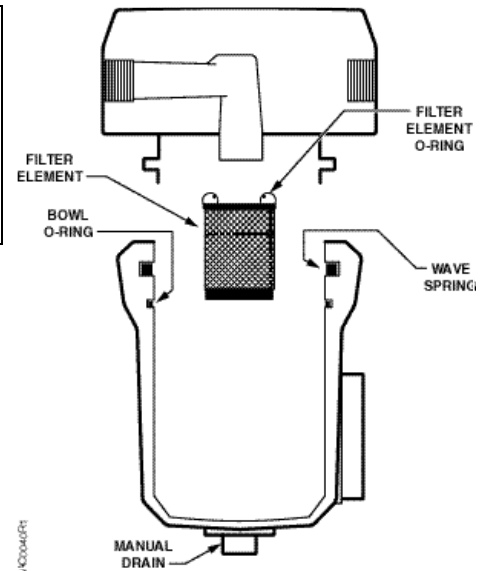

Figure 2. Filter Element Replacement.